

LUXMESH™

LATTICE

LED Backlighting

POWERFULLY BRIGHT ILLUMINATION

Discover a versatile grand format backlighting solution that combines brilliant, innovative illumination with an energy-efficient design when you use **LUXMESH™ LED Lattice** to backlight large format graphics, such as those printed on our Profile 100 and 120 series Fabric Light Boxes. Featuring a wide beam angle, energy-saving design and consistent lighting output, LUXMESH™ is the designer's choice for backlighting even surfaces, including simple curved applications. Fully adjustable to meet your application's unique needs, mix and match the standard module sticks and combine them to your desired length for a custom fit that will provide full coverage without hot spots.



Powerful grand format backlighting made easy



STRONG COLOR RENDERING



OUTSTANDING BRIGHTNESS



EVEN LIGHTING NO DARK SPOTS



LONG LED LIFESPAN

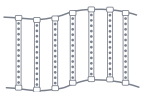

CONTOURS FOR SIMPLE CURVES

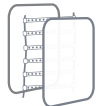

EFFECTIVE BACKLIGHTING SOLUTION



WIDE BEAM ANGLE



80% ENERGY EFFICIENT



CUSTOM ROLL LENGTHS



CUSTOM COLORS



CONSTANT POWER - 24V

ASSURED QUALITY



E477011



100% QC MANUFACTURER'S WARRANTY



LEDCONN

— Be the FOCUS —



(714) 256-2111



sales@ledconn.com



(714) 256-2118



301 Thor Place
Brea, CA, 92821



www.ledconn.com



LARGE FORMAT FABRIC LIGHT BOX FOR EXHIBIT



ILLUMINATED LED LATTICE

APPLICATIONS

- Sign Cabinet Backlighting
- Fabric Light Box Backlighting
- Ceiling & Wall Backlighting
- Large Format Illumination
- Simple Curved Applications
- ...And Many More!

SPECIFICATION SUBMITTAL

JOB NAME / NUMBER

PART NUMBER

MECHANICAL

LED MODULE

- LED Count** 3, 6, & 12 pc/stick
- PCB** 3/16" (w) x 9/32" (h) [20mm (w) x 7mm (h)]
- LED Pitch** 3-5/32" (80mm)
- Stick-to-Stick Pitch** 6" (152mm)
- No. of Sticks per Roll** 12 sticks
- Max. Roll Length** Unlimited
- Ambient Temperature** -4°F~+176°F (-20~+80°C)
- IP Rating** IP60*
- Environment** Indoor applications

*EXTERIOR applications (IP 65) available upon request

MOUNTING

Method

- Screws or
- Double-sided foam tape

Optimal Cabinet Depth** 3"-5" (76mm-127mm)

**Optimal depth to prevent hot spots

ELECTRICAL

LIGHT SOURCE

- LED Chip** Nichia 3030 LED
- Wide Beam Angle** 160° with Optical Lens
- Life Expectancy** 50,000+ hours
- Color Rendering** CRI 80+
- Standard Color** Cool White (6500K)
- Available Colors**
 - Daylight (5300K)
 - Neutral White (4100K)
- Dimmable** Compatible with pulse-width modulation dimming (PWM) & 0-10V dimming
- UL Listed** E477011

POWER SUPPLY

- Input Voltage** 24Vdc constant current
- Wire Size** 20 AWG 2 Wire
- Please use only with Class 2 power supply**
- Connector Type**
 - Molex®
 - Hardwire

AVAILABLE
COLOR TEMP.
(CCT)

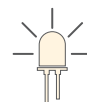

Neutral White
4100K

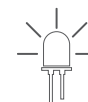

Daylight
5300K

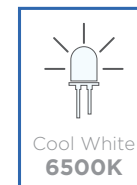

Cool White
6500K

STANDARD

SIZE	STICK WIDTH	LED/STICK	ROLL LENGTH	LED	BRIGHTNESS (lm/stick)	EFFICACY (lm/W)	POWER (W/stick)	MAX LOAD (96W)
Short	9-1/2" (241mm)	3	72" (1829mm)	IP60	320	86.5	3.7	24 sticks
Medium	19-1/4" (489mm)	6	72" (1829mm)	IP60	650	86.7	7.5	12 sticks
Long	37-3/4" (959mm)	12	72" (1829mm)	IP60	1300	86.7	15.0	6 sticks

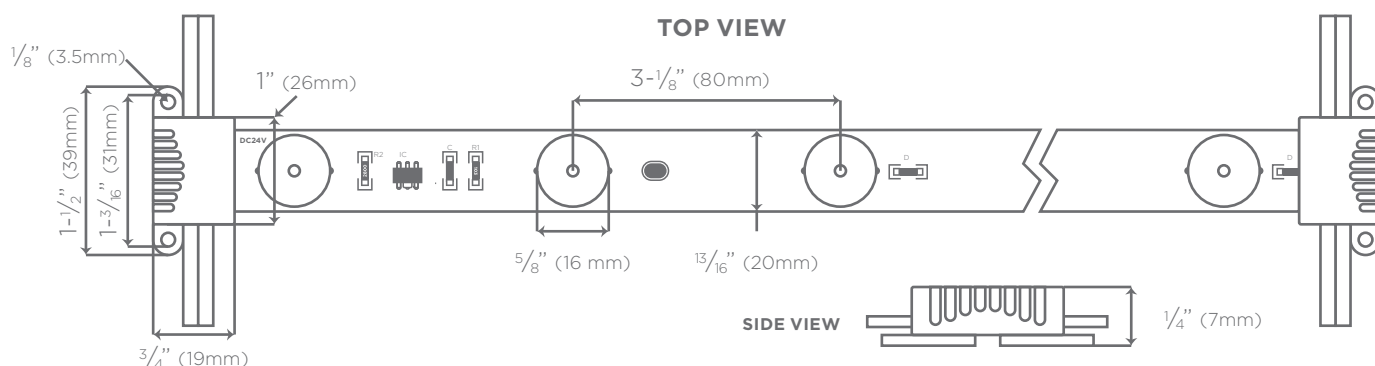

ILLUSTRATION NOT DRAWN TO SCALE

SPECIFICATION SUBMITTAL

JOB NAME / NUMBER	PART NUMBER
-------------------	-------------

AVAILABLE PRODUCTS

MIX & MATCH 3 BAR SIZES

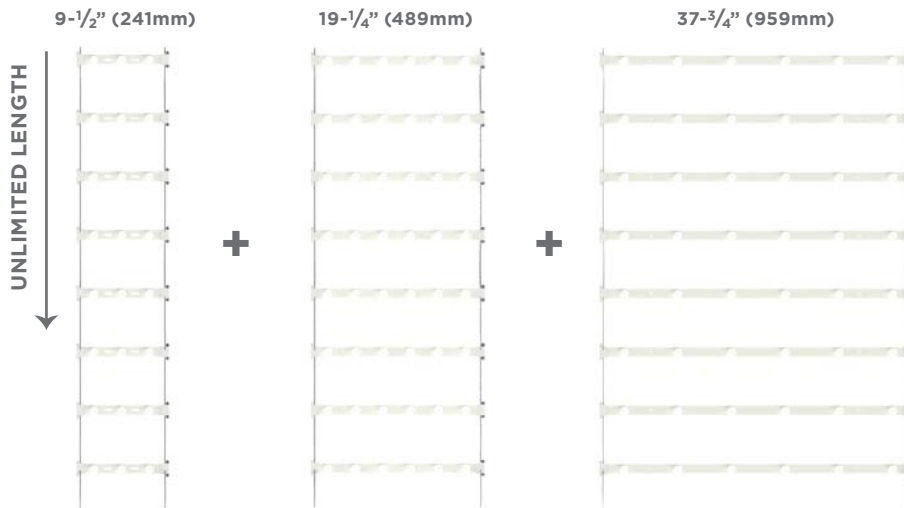

**UNLIMITED
COMBINATIONS
& LENGTHS**

LINK LED STICKS HORIZONTALLY
OR VERTICALLY WITHOUT LIMIT

LATTICE PART NUMBER ORDER SHEET

EXAMPLE

M3872WM	LUXMESH	LONG STICK	72"	6500K	MOLEX
	M	38	72	W	M
	PRODUCT LINE/PROFILE	STICK WIDTH	ROLL LENGTH (MULTIPLES OF 6 ONLY)	COLOR	CONNECTOR
BUILD IT!					

PRODUCT LINE

M LUXMESH™

STICK WIDTH

- 09** 9-1/2" (SHORT)
- 19** 19-1/4" (MEDIUM)
- 38** 37-3/4" (LONG)

ROLL LENGTH (MULTIPLES OF 6 ONLY)

LL LENGTH (VARIES)

COLOR TEMPERATURE (CCT)

- W** 6500K
- V** 5300K
- Y** 4100K
- C** CUSTOM CCT

CONNECTOR

- M** MOLEX
- H** HARDWIRE

SPECIFICATION SUBMITTAL

JOB NAME / NUMBER	PART NUMBER
-------------------	-------------